

RXN Series Linear DC Stabilized Power Supply

Manual

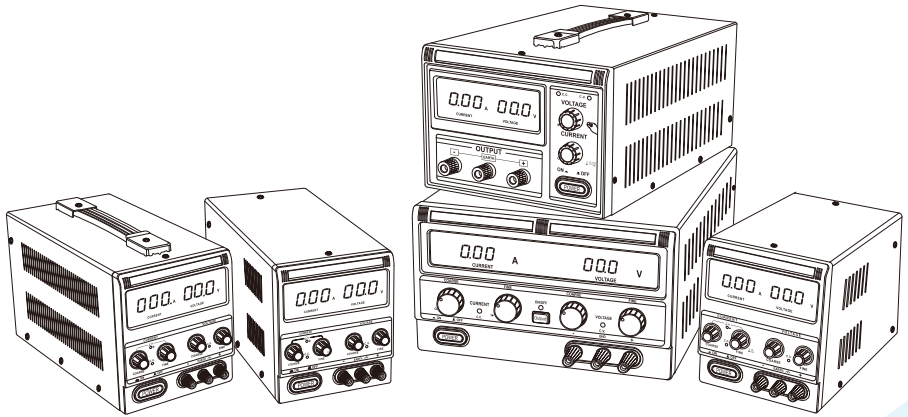

Table of Content

General Security Overview	1
Preface	2
Main Functions	2
Start Guide	2
Standard Accessories and Selection	2
Product Size	2-3
Technical Parameter	4-5
Operational Requirements	6
System Installation	6
Product Cleaning	8
Operating Basis	8
Overview of Front Panel	8-9
Overview of Rear Panel	10
Connection of Load Line	11
Characteristics of Constant Voltage/Constant Current	11
Function Description Model B	12
Constant Voltage Operation	12
Constant Current / Current-Limit Setting Operation	12
Function Description C Model	13
Constant Voltage Operation	13
Constant Current / Current-Limit Setting Operation	14
Function Description E Model	15
Constant Voltage Operation	15
Constant Current / Current-Limit Setting Operation	16
Common Troubleshooting	17
Fuse change	17

General Security Overview

Please read the following security precautions carefully to avoid personal injury, and prevent damage to the product or any products connected to this product. In order to avoid possible danger, you are required to use the product in accordance with regulations. Only qualified personnel are allowed to perform repair process.

Avoid fire or personal injury

Use the suitable power line. Please use only the power line designed for this product and certified by country/region where it is located.

Use correct voltage settings. Before power-on, please ensure that line selector is set at corresponding position of current voltage.

Product grounding. This product should be grounded through earth conductor of the power line. The earth conductor must be connected to the earth, in order to avoid electric shock. Before connecting with the input or output terminals of this product, you should ground the product correctly.

Observe all rated values of terminal. Please observe all rated values and markings on the product, to avoid risks of fire or electric shock. Before connecting the product, you can consult the manual firstly for detailed information about rated values.

Disconnect the power. The power switch can disconnect the product from power source. Please refer to the description of relevant locations. Do not block the power switch; the power switch must be available for the user at any time.

Do not open the cover. Do not operate this product with the outside cover or panel open.

Do not operate the product when you suspect that it malfunctions. If you suspect that the product is damaged already, please have it inspected by qualified service personnel.

Keep away from exposed circuits. After power-on, do not touch exposed circuits and components.

Use the suitable fuse. Please only use the fuse type and rated index specified for the product.

Do not operate the product in a humid environment.

Do not operate the product in a flammable and explosive environment.

Please keep the surface of the product clean and dry.

Please ventilate properly. For more details on how to install the product to maintain proper ventilation, please refer to installation instructions in the Manual.

Terminology in this Manual

The Manual probably includes the following terms:



WARNING

ti ndicates situations or operations that may cause personal injury or endanger life.



CAUTION

It points out situations or operations that may cause damage to this product or other properties.

Symbols and terms on the product

The following terms may be marked on the product:

- “DANGER” means injury that will occur immediately when you read this mark.
- “WARNING” represents injury that will not happen immediately when you read this mark.
- “CAUTION” indicates possible danger to this product or other properties.

The following symbols may be marked on this product:



Protective Earth Terminal



Ground terminal



Positive Electrode



Negative Electrode



Warning for High Voltage



CAUTION

Preface

Main Functions

- Current preset, current-limiting protection.
- Automatic switching of constant voltage/constant current.
- Fine adjustment knob of voltage/current (in some models)
- Three-digit display of voltage and current, with display accuracy 0.1V 0.01A
- Four-digit display of current, with display accuracy 0.01V 0.001A (in some models)
- Low noise: Temperature-controlled fan is adopted, and it starts automatically to dissipate heat when internal temperature is greater than 50°C.

Start Guide

Standard Accessories and Selection

Tab. 1: Standard Accessories

Power host	1 set
Input power line	1
Manual	1
Warranty certificate	1

Table 2: Accessories Selection (power plug)

North America AC 110V	European General AC 220V
UK AC 220V	Australia AC 220V
Switzerland AC 220V	India AC 220V
Brazil AC 220V	

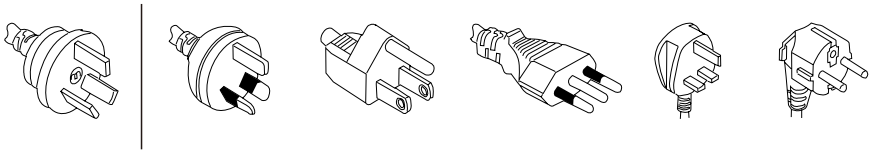

Product Size (A model)

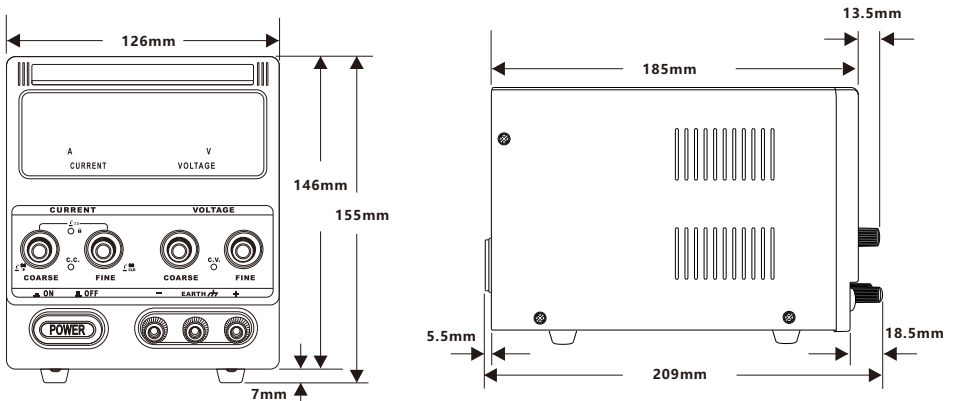

Product Size (B model)

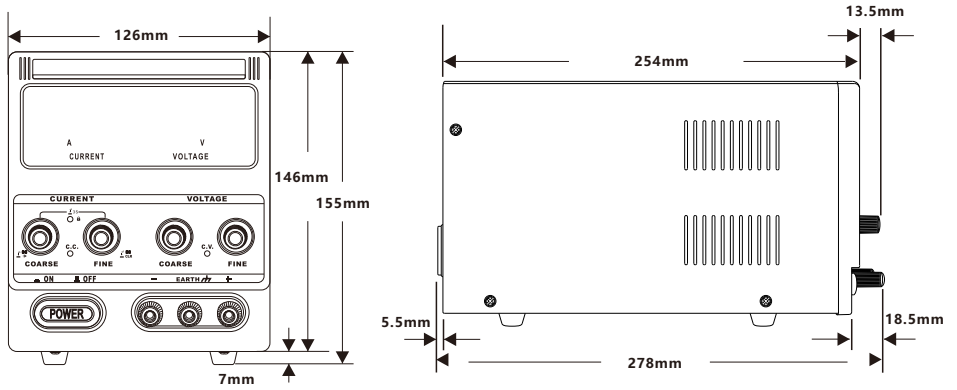

Product Size (C model)

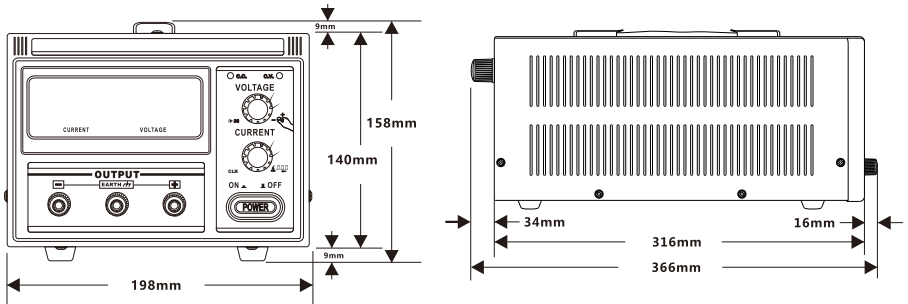

Product Size (D model)

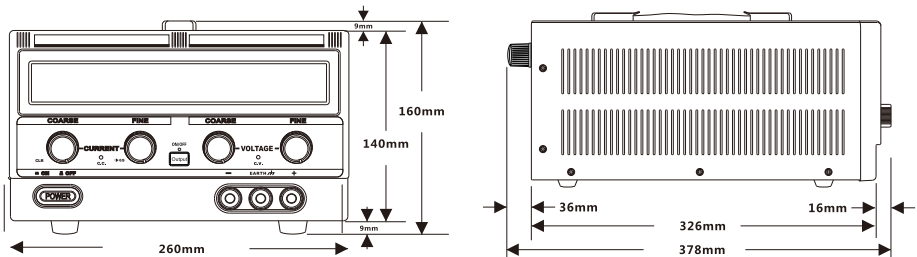

Preface

Technical Parameter

Tab. 1:

Type:	RXN-1505D	RXN-303D	RXN-305D	RXN-602D	RXN-603D	RXN-605D
Input voltage:	<input type="checkbox"/> AC 220V±10% 50Hz <input type="checkbox"/> AC 110V±10% 60Hz <input type="checkbox"/> AC 240V±10% 50Hz					
Temperature:	Working temperature: -10℃~40℃ Relative humidity < 80% Storage temperature: -10℃~40℃ Relative humidity < 90%					
Output voltage:	0-15V	0-30V	0-30V	0-60V	0-60V	0-60V
Output current:	0-5A	0-3A	0-5A	0-2A	0-3A	0-5A
Voltage-stabilized state:	Voltage stabilization degree ≤0.05%+2mV Load stability ≤0.05%+2mV Ripple noise ≤1mVrms (effective value)					
Steady-flow state:	Current stabilization degree ≤0.1%+3mA Load stability ≤0.2%+3mA					
Display accuracy:	3-digit LED digital display of voltage/current ±1%/±1%±1 character					
Display resolution:	Voltage 0.1V Current 0.01A					
Boundary dimension:	209 (depth)	278 (depth) * 126 (width) * 155 (height)				
Weight:	3.2KG	3.64KG	4.78KG	4.46KG	5.08KG	6.88KG

Tab. 2:

Type:	RXN-303DM	RXN-305DM	RXN-602DM	RXN-603DM	RXN-605DM
Input voltage:	<input type="checkbox"/> AC 220V±10% 50Hz <input type="checkbox"/> AC 110V±10% 60Hz <input type="checkbox"/> AC 240V±10% 50Hz				
Temperature:	Working temperature: -10℃~40℃ Relative humidity < 80% Storage temperature: -10℃~40℃ Relative humidity < 90%				
Output voltage:	0-30V	0-30V	0-60V	0-60V	0-60V
Output current:	0-3A	0-5A	0-2A	0-3A	0-5A
Voltage-stabilized state:	Voltage stabilization degree ≤0.05%+2mV Load stability ≤0.05%+2mV Ripple noise ≤1mVrms (effective value)				
Steady-flow state:	Current stabilization degree ≤0.1%+3mA Load stability ≤0.2%+3mA				
Display accuracy:	3-digit LED digital display of voltage/current ±1%/±1%±1 character				
Display resolution:	Voltage: 0.01V/0.1V Current: 0.01A/0.01mA				
Boundary dimension:	278 (depth) * 126 (width) * 155 (height)				
Weight:	3.64KG	4.78KG	4.46KG	5.08KG	6.88KG

Preface

Technical Parameter

Tab. 3:

Type:	RXN-1520D	RXN-3010D	RXN-1530D
Input voltage:	<input type="checkbox"/> AC 220V±10% 50Hz <input type="checkbox"/> AC 110V±10% 60Hz <input type="checkbox"/> AC 240V±10% 50Hz		
Temperature:	Working temperature: -10℃~40℃ Relative humidity < 80% Storage temperature: -10℃~40℃ Relative humidity < 90%		
Output voltage:	0-15V	0-30V	0-15V
Output current:	0-20A	0-10A	0-30A
Voltage-stabilized state:	Voltage stabilization degree ≤0.05%+2mV Load stability ≤0.05%+2mV Ripple noise ≤2mVrms (effective value)		
Steady-flow state:	Current stabilization degree ≤0.2%+3mA Load stability ≤0.2%+3mA		
Display accuracy:	3-digit LED digital display of voltage/current ±1%±1 character		
Display resolution:	Voltage 0.1V Current 0.1A	Voltage 0.1V Current 0.1A/0.01A	Voltage 0.1V Current 0.1A
Boundary dimension:	366 (depth) × 198 (width) × 158 (height)		378 (depth) × 260 (width) × 169 (height)
Weight:	8.8KG	8.1KG	14.6KG

Tab. 4:

Type:	RXN-3020D	RXN-3030D	RXN-6010D
Input voltage:	<input type="checkbox"/> AC 220V±10% 50Hz <input type="checkbox"/> AC 110V±10% 60Hz <input type="checkbox"/> AC 240V±10% 50Hz		
Temperature:	Working temperature: -10℃~40℃ Relative humidity < 80% Storage temperature: -10℃~40℃ Relative humidity < 90%		
Output voltage:	0-30V	0-30V	0-60V
Output current:	0-20A	0-30A	0-10A
Voltage-stabilized state:	Voltage stabilization degree ≤0.05%+2mV Load stability ≤0.1%+2mV Ripple noise ≤2mVrms (effective value)		
Steady-flow state:	Current stabilization degree ≤0.2%+3mA Load stability ≤0.2%+3mA		
Display accuracy:	3-digit LED digital display of voltage/current ±1%±1 character		4-digit LED digital display of voltage/current ±0.5%±1 character
Display resolution:	Voltage 0.1V Current 0.1A		Voltage 0.1V Current 0.01A
Boundary dimension:	378 (depth) × 260 (width) × 169 (height)		
Weight:	14KG	19.6KG	13.6KG

Operational Requirements

1. Place the instrument on a workbench or similar surface.
2. Before operation, please make sure that the ambient temperature is $+0^{\circ}\text{C} \sim +40^{\circ}\text{C}$ ($+32^{\circ}\text{F} \sim +104^{\circ}\text{F}$)



WARNING: To ensure normal heat dissipation, please do not stack objects on the front, sides, or back of the instrument. A ventilation space at least 3cm should be reserved at the side and back of the instrument, to ensure air circulation of the instrument.

WARNING: Before using the product and any related instruments, you should ensure that all security precautions listed in this manual are followed. Although some instruments and accessories are only used under non-hazardous voltages, danger may also occur. Only qualified personnel are allowed to use this product because they need to be able to recognize risk of electric shock and be familiar with necessary security precautions, to avoid possible injuries. Before use, you are recommended to read and follow all regulations of installation, Operation and maintenance information carefully. For complete product technical specifications, please refer to this manual. Before performing any maintenance, you should disconnect the power line and all test cables. Operators of this instrument must take protective measures against electric shock at all times. The responsible agency must ensure that operators cannot touch any connection points and/or maintain insulation from each connection point. In some cases, the connection point must be exposed, which may cause physical contact. In this case, operators must be trained to know how to protect themselves from the risk of electric shock. Provided that circuits can work normally at 72 volts or higher, any conductive parts in the circuits must not be exposed.



WARNING: Please use wires with an appropriate rated load. The capacity of all load wires must be able to carry the maximum short-circuit output current of the power supply, without overheating. If there are multiple loads, each pair of load wires should safely bear the full rated short-circuit output current of the power supply.



WARNING: Do not loosen any screws on this product. There are no user-serviceable components inside.



WARNING: In order to reduce the risk of fire and electric shock, you should refer to the range of rated values of the power supply.

System Installation

- Open package of the instrument and check whether you have received all the items listed in the “standard accessories”.
- Also, check you have received all other accessories ordered with the instrument or not.
- Please visit zhaoxin website (www.zhaoxinpower.com) for the latest information.

Please perform the following steps, to confirm that the power supply is ready:

Power on and off the Instrument Power

Please power on the instrument power and perform the following steps:

1. Complete all connections.
2. Connect the power line provided with the instrument to the power connector on the rear panel. Then, connect the power line plug to a properly grounded power socket.

Operational Requirements

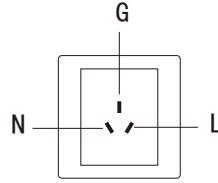
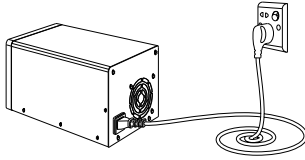

3. Press power button on the front panel to power off the instrument.



WARNING: In order to meet security requirements, you need to ensure that load wire used must always be able to carry the maximum short-circuit output current of the power supply, without overheating. If there are multiple loads, each pair of load wires must safely bear full rated current of power supply.

How to Solve the Problem That Power Supply Fails

Please perform the following steps, in order to avoid possible problems when the instrument is turned on:

1. Verify whether there is AC at the AC input end of the power supply. Firstly, inspect whether AC power line is firmly inserted into power connector on the rear panel of power supply. Also, check whether AC power line connected to the power supply is powered on. Second, check whether the power switch is turned on.
2. Verify voltage setting of power input. Inspect label on the back of instrument to see if nominal input voltage is suitable for your country/region (AC 110V or 220V). Note: In some cases, fuse of electric supply may disconnect if the instrument is powered with an incorrectly configured mains voltage.
3. Make sure that power line fuse has been installed correctly. If the fuse is damaged, please change it.
4. For more help, please contact zhaoxin.

Output Check

The following steps are used to check whether power supply produces rated output and whether it can correctly respond to operations from the front panel.

Voltage Output Check: Please operate the following steps to check basic voltage function under no-load conditions.

1. Remove all guide lines from the output connector.
2. Turn on the power.
3. Turn the current adjustment knob of power supply clockwise to the maximum.
4. In constant voltage output state of power supply, the C.V light is on. Check whether the voltage adjustment knob can be adjusted from 0V to the maximum value of rated range.

Current Output Check: Please operate the following steps to verify basic current function in the case of a short circuit between power supply outputs:

1. Remove all guide lines from the output connector.
2. Turn on the power.
3. Set the output voltage to about 5-6V.
4. Use insulated test leads to connect a short circuit between (+) and (-) output terminals. The size of guide lines used should be able to bear electric wire with the maximum current.



WARNING: To meet security requirements, the load wire used must always be sufficient to carry the maximum short-circuit output current of power supply, without overheating. If there are multiple loads, each pair of load wires must be able to safely bear full rated current of power supply.

5. Turn off the power and remove short-circuit wire between (+) and (-) output terminals.

Operational Requirements

Product Cleaning

Regularly check the power supply in accordance with operating conditions. Please clean outer surface of the instrument as per following steps:

1. Use a lint-free rag to remove floating dust on surface of power supply.
Be careful to avoid scratching the displayer.
2. Use a soft cloth dampened with water to clean the power supply. For more thorough cleaning, please use 75% isopropanol in water.

Operating Basis

Overview of Front Panel

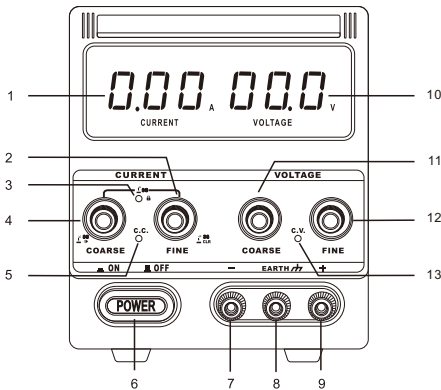

The following diagram and table illustrate the various controls and display elements.

1. Current (Left) Output Display
2. Current (Fine) Adjustment Knob / Current Display Reset (Hold knob for 3 seconds)
3. Knob Lock Indicator (Enable/Disable by holding both coarse/fine current knobs for 3 seconds)
4. Current (Coarse) Adjustment Knob / Sound On/Off (Hold knob for 3 seconds)
5. C.C. Constant Current Indicator Light
6. Power On/Off
7. Output Terminal Negative (-)
8. Ground Terminal
9. Output Terminal Positive (+)
10. Voltage (Right) Output Display
11. Voltage (Coarse) Adjustment Knob
12. Voltage (Fine) Adjustment Knob
13. C.V. Constant Voltage Indicator Light

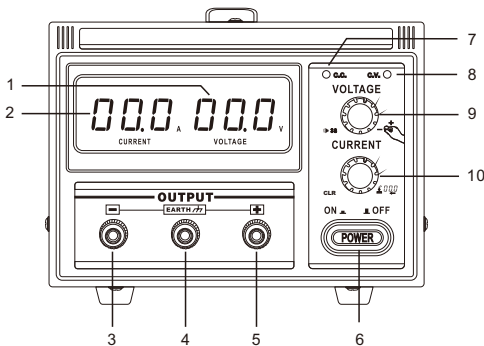

The following diagram and table illustrate the various controls and display elements.

1. Voltage (Right) Output Display
2. Current (Left) Output Display
3. Output Terminal Negative (-)
4. Ground Terminal
5. Output Terminal Positive (+)
6. Power On/Off
7. C.C. Constant Current Indicator Light
8. C.V. Constant Voltage Indicator Light
9. Voltage Adjustment Knob / Sound On/Off / Decimal Adjustment
10. Current Adjustment Knob / Decimal Adjustment / Display Reset

Operating Basis

Overview of Front Panel

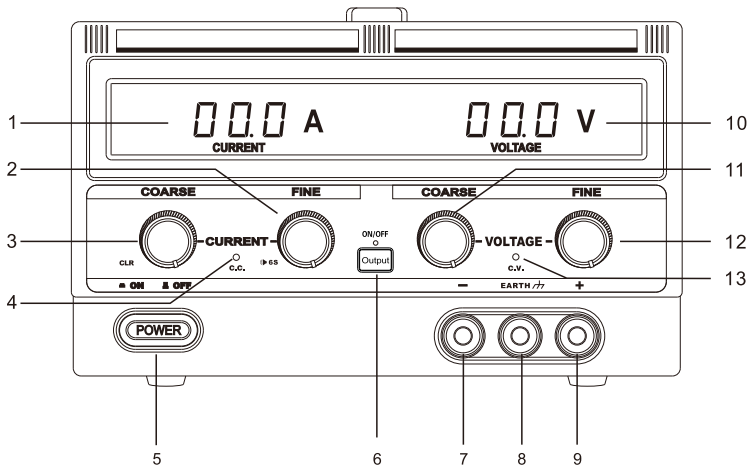

The following diagram and table illustrate the various controls and display elements.

1. Current (Left) Output Display
2. Current (Fine) Adjustment Knob / Sound On/Off
3. Current (Coarse) Adjustment Knob / Current Display Reset
4. C.C. Constant Current Indicator Light
5. Power On/Off
6. Output Power Switch
7. Output Terminal Negative (-)
8. Ground Terminal
9. Output Terminal Positive (+)
10. Voltage (Right) Output Display
11. Voltage (Coarse) Adjustment Knob
12. Voltage (Fine) Adjustment Knob
13. C.V. Constant Voltage Indicator Light

Operating Basis

Overview of Rear Panel

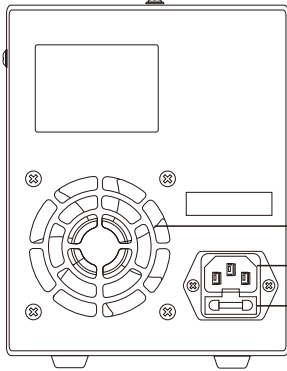

1. Cooling fan
2. AC power connector
3. AC fuse box

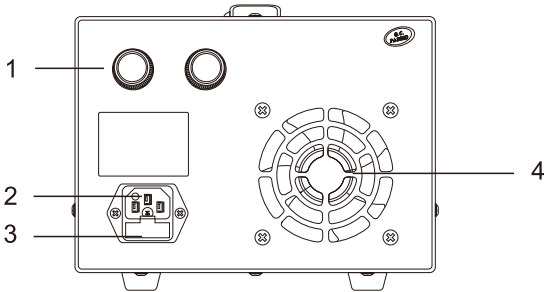

1. High-power output terminal (in some models)
2. AC power connector
3. AC fuse box
4. Cooling fans

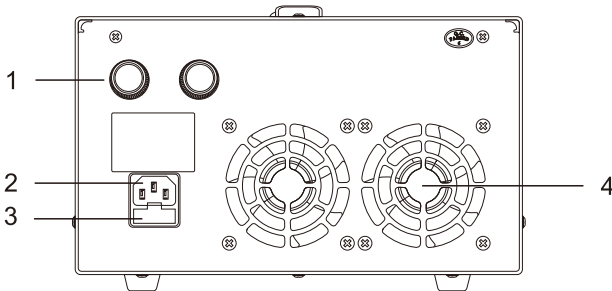

1. High-power output terminal (in some models)
2. AC power connector
3. AC fuse box
4. Cooling fans

Operating Basis

Connection of Load Line

1. Rotate terminal counterclockwise to loosen the terminal
2. Insert load line terminal
3. Rotate terminal clockwise to lock the terminal
4. Banana plug: insert the banana plug into terminal block

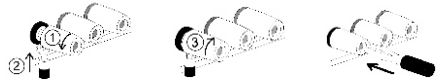

Type of load line: The load line is an optional accessory for users, and current capacity of load line must be confirmed when the load line is purchased. The voltage drop at both ends of each load line cannot exceed 0.5V. The following table shows rated current of the load line.

Characteristics of Constant Voltage/Constant Current

1. The DC power supply can automatically switch between constant voltage mode (C.V.) and constant current mode (C.C.) according to load conditions. When output current is less than output preset value, the DC power supply works in constant voltage mode, and front panel indicator lights green (C.V.). The output voltage is constant at the set value; when output current changes with the load and the current reaches the preset value, the power supply enters a constant current mode (C.C.). Indicator on the front panel is red (C.C.) The current output will be constant at the preset value, and output voltage will vary with the load. When the output current is less than the preset value, DC power supply will automatically return to constant voltage mode (C.V.)

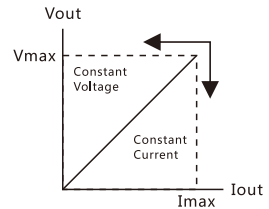

Note 1: Incorrect connection may cause damage to power supply or the load connected to DC power supply.

2. In actual (C.V.) operation, if output current increases to the setting value due to decrease of load resistance, the power supply will automatically switch to (C.C.) mode. When load resistance continues to decrease, the current will remain at the setting value. The voltage will decrease proportionally ($I=V/R$). At this time, C.V. output state can be restored by increasing load resistance or improving setting value of current.
3. In actual (C.C.) operation, if output voltage increases to the setting value due to increase of load resistance, the power supply will automatically switch to (C.V.) mode. When load resistance continues to increase, the voltage will remain at the setting value. The current will decrease proportionally ($I=V/R$). At this time, C.C. state can be restored by reducing load resistance or increasing setting value of voltage.

Operating Basis

Function Description Model B



Knob sound on/off

In standby state, long press coarse adjustment knob of current for 3s to turn off the sound. If you need to turn it off, please repeat the above operation to turn on knob sound.



Current display reset

Without any load, long press fine adjustment knob of current for 3s and then you can reset current display digital after hearing the "DI" sound.

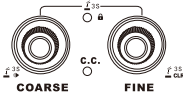

Knob lock

In standby mode, long press and hold the current coarse and fine adjustment knob for 3 seconds, and the indicator light will turn on. The 4 power knobs are locked. To unlock, repeat the above operation and the indicator light will turn off to unlock the state.

Constant Voltage Operation

For example: the voltage is set to 12V, and the current is 5A.

Steps:

1. Turn on the power switch
2. Voltage setting: Use coarse/fine adjustment knob of voltage to set the voltage to 12V
3. Current setting: Use coarse/fine adjustment knob of current to set the current to 5A, and the current displayed is preset current at this time.
4. Connect the load

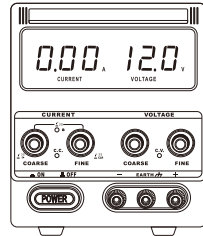
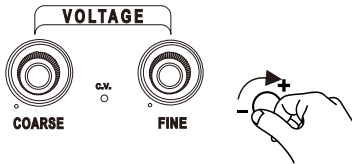

Constant Current / Current-Limit Setting Operation

For example: set constant current or current-limit to 3A.

Steps:

1. Current setting: Use coarse/fine adjustment knob of current to set the current to 3A, and the current displayed is preset current at this time.
2. Connect the load

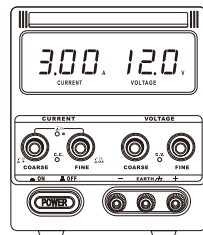
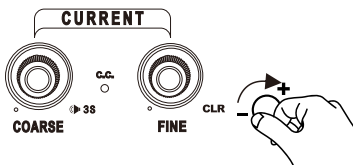

Operating Basis

Function Description Model C

VOLTAGE



Knob sound on/off

In standby state, long press coarse adjustment knob of current for 3s to turn off the sound. If you need to turn it off, please repeat the above operation to turn on knob sound.



Display shift

Shift the display by short pressing voltage or current adjustment knob until Nixie tube flashes 00.0

Use  knob to change value and flash for

3 seconds to automatically confirm.

CURRENT



Current display reset

Without any load, long press fine adjustment knob of current for 3s and then you can reset current display digital after hearing the "DI" sound. Use scenario: When power supply is used for a long time, current display of power supply may not return to zero under no load. The zero position can be cleared by following operations.

Constant Voltage Operation

For example: the voltage is set to 12V, and the current is 10A.

Steps:

1. Turn on the power switch
2. Voltage setting: Use coarse/fine adjustment knob of voltage to set the voltage to 12V
3. Current setting: Use coarse/fine adjustment knob of current to set the current to 10A, and the current displayed is preset current at this time.
4. Connect the load

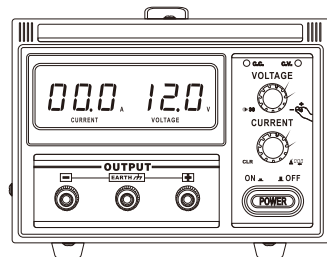
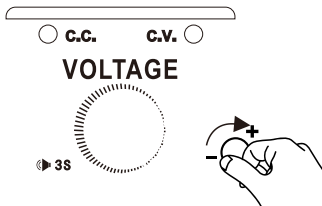

Operating Basis

Constant Current / Current-Limit Setting Operation

For example: set constant current or current-limit to 10A.

Steps:

1. Current setting: Use coarse/fine adjustment knob of current to set the current to 10A, and the current displayed is preset current at this time.
2. Connect the load

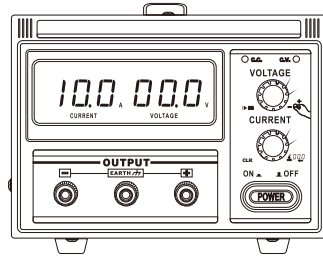
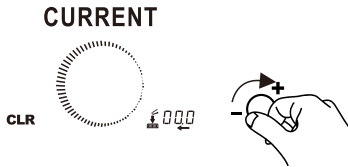

When output current is greater than or equal to 10A, please use output terminal on the rear panel firstly and lock it tightly. (Avoid terminal burnout due to heat caused by poor contact)

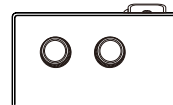

Operating Basis

Function Description Model D

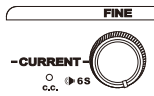

Knob sound on/off

in standby, long press adjustment knob of voltage for 6s to turn off the sound. If you need to turn it off, please repeat the above operation to turn on knob sound.

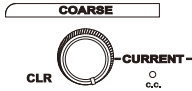

Current display reset

Without any load, long press fine adjustment knob of current for 3s and then you can reset current display digital after hearing the "DI" sound. Use scenario: When power supply is used for a long time, current display of power supply may not return to zero under no load. The zero position can be cleared by following operations.

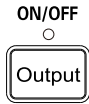

Power output control on/off

The default setting is (Off). Long press Output button for 3 seconds to turn off power output control. (At this time, power output terminal is always in a charged state). If you want to turn off power output control, long press the Output button again for 6s. Short press Output button means to start or turn off.

Constant Voltage Operation

For example: the voltage is set to 24V, and the current is 20A.

Steps:

1. Turn on the power switch
2. Voltage setting: Use coarse/fine adjustment knob of voltage to set the voltage to 24V
3. Current setting: Use coarse/fine adjustment knob of current to set the current to 20A.
Note: current displayed is preset current at this time.
4. Connect the load and press the Output button to output.

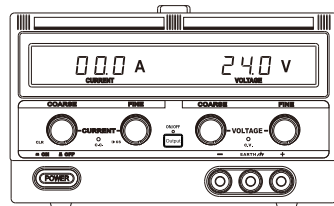
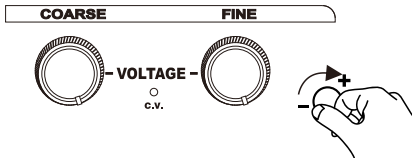

Constant Current / Current-Limit Setting Operation

For example: set constant current or current-limit to 20A.

Steps:

1. Current setting: Use coarse/fine adjustment knob of current to set the current to 20A.
Note: current displayed is preset current at this time.
2. Connect the load and press the Output button to output.

Operating Basis

Constant Current / Current-Limit Setting Operation

For example: set constant current or current-limit to 20A.

Steps:

1. Current setting: Use coarse/fine adjustment knob of current to set the current to 20A.
Note: current displayed is preset current at this time.
2. Connect the load and press the Output button to output.

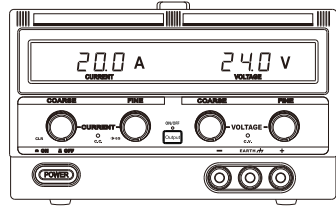
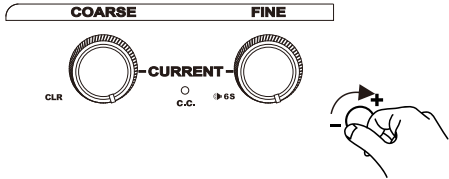

CAUTION

When output current is greater than or equal to 10A, please use output terminal on the rear panel firstly and lock it tightly. (Avoid terminal burnout due to heat caused by poor contact)

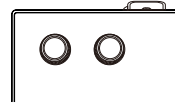

Common Troubleshooting

When you press power switch on the front panel, the display goes blank without any display

1. Check whether power connector is connected properly.
2. Check whether the fuse is correct and intact.

Abnormal constant voltage output:

1. Check maximum output power meets load requirements or not.
2. If it is satisfied, please check whether current setting value is appropriate. If it is too low, you can appropriately increase the setting value; whether there is a short circuit or open circuit in the cable connecting the load and power supply; whether the cable is in good contact and whether there is a problem with the load.

Abnormal constant current output:

1. Check maximum output power meets load requirements or not.
2. If it is satisfied, please check whether voltage setting value is appropriate. If it is too low, you can appropriately increase the setting value; whether there is a short circuit or open circuit in the cable connecting the load and power supply; whether the cable is in good contact and whether there is a problem with the load.

Fuse change

1. Cut off the power and take out the fuse holder with a slot type screwdriver
2. Change the fuse

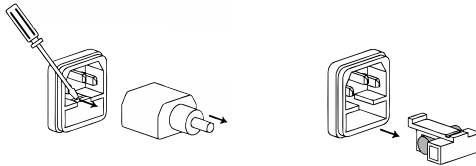

In order to ensure safe and effective fire protection measures, you can only change the fuse with specific specifications and rated value. Before replacement, please cut off the power supply and remove power line from power socket.

SCANNING IT



Follow Official WeChat of
**SHENZHEN ZHAOXIN Electronic
Instrument Equipment Co., Ltd.**
Experience more discounts and
more services You can also search
for our official WeChat account:
Zhaoxin Electronic Instrument

ZHAOXIN[®]

Shenzhen Zhaoxin Electronic Instrument Equipment Co., Ltd.

Address: F/4, Building 3, Tianli Industrial Zone, Xueyuan Road, Longxi Community,
Longgang Subdistrict, Longgang District, Shenzhen

Marketing Center: Shenzhen Zhaoxin Electronic Instrument Equipment Co., Ltd.

Tel: (86-755)83957113 Fax: (86-755)83010865

Email: admin@zhaoxinpower.com

Website: www.zhaoxinpower.com

Product: DC voltage-stabilized power supply

Product implementation standard: GBT-17478